

TOSHIBA PHOTOCOUPLER GaAs IRED & PHOTO-TRIAC

TLP560G

TRIAC DRIVER

PROGRAMMABLE CONTROLLERS

AC-OUTPUT MODULE

SOLID STATE RELAY

The TOSHIBA TLP560G consists of a photo-triac optically coupled to a gallium arsenide infrared emitting diode in a six lead plastic DIP package.

- Peak Off-State Voltage : 400V (MIN.)
- On-State Current : 100mA (MAX.)
- Isolation Voltage : 2500V_{rms} (MIN.)
- UL Recognized : File No. E67349
- Isolation Operating Voltage : 2500V_{ac} or 300V_{dc} for Isolation Groupe C*1
- Trigger LED Current

CLASSIFICATION*	TRIGGER LED CURRENT (mA)		MARKING OF CLASSIFICATION
	V _T = 6V, T _a = 25°C		
	MIN.	MAX.	
(IFT5)	—	5	T5
(IFT7)	—	7	T5, T7
Standard	—	10	T5, T7, Blank

*Ex. (IFT5) ; TLP560G (IFT5)

(Note) Application type name for certification test, please use standard product type name, i.e.

TLP560G (IFT5) : TLP560G

*1 : According to VDE0110, table 4.

Unit in mm

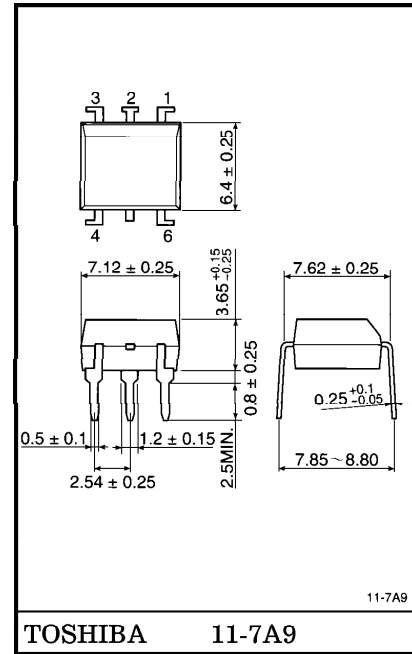

Weight : 0.39g

PIN CONFIGURATION (TOP VIEW)

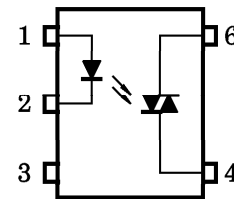

- 1 : ANODE
- 2 : CATHODE
- 3 : N.C.
- 4 : TERMINAL 1
- 6 : TERMINAL 2

961001EBC2

- TOSHIBA is continually working to improve the quality and the reliability of its products. Nevertheless, semiconductor devices in general can malfunction or fail due to their inherent electrical sensitivity and vulnerability to physical stress. It is the responsibility of the buyer, when utilizing TOSHIBA products, to observe standards of safety, and to avoid situations in which a malfunction or failure of a TOSHIBA product could cause loss of human life, bodily injury or damage to property. In developing your designs, please ensure that TOSHIBA products are used within specified operating ranges as set forth in the most recent products specifications. Also, please keep in mind the precautions and conditions set forth in the TOSHIBA Semiconductor Reliability Handbook.
- Gallium arsenide (GaAs) is a substance used in the products described in this document. GaAs dust and fumes are toxic. Do not break, cut or pulverize the product, or use chemicals to dissolve them. When disposing of the products, follow the appropriate regulations. Do not dispose of the products with other industrial waste or with domestic garbage.
- The products described in this document are subject to foreign exchange and foreign trade control laws.
- The information contained herein is presented only as a guide for the applications of our products. No responsibility is assumed by TOSHIBA CORPORATION for any infringements of intellectual property or other rights of the third parties which may result from its use. No license is granted by implication or otherwise under any intellectual property or other rights of TOSHIBA CORPORATION or others.
- The information contained herein is subject to change without notice.

MAXIMUM RATINGS (Ta = 25°C)

CHARACTERISTIC		SYMBOL	RATING	UNIT
LED	Forward Current	I _F	50	mA
	Forward Current Derating (Ta ≥ 53°C)	ΔI _F / °C	-0.7	mA / °C
	Peak Forward Current (100μs pulse, 100pps)	I _{FP}	1	A
	Reverse Voltage	V _R	5	V
	Junction Temperature	T _j	125	°C
DETECTOR	Off-State Output Terminal Voltage	V _{DRM}	400	V
	On-State RMS Current	Ta = 25°C	100	mA
		Ta = 70°C	50	
	On-State Current Derating (Ta ≥ 25°C)	ΔI _T / °C	-1.1	mA / °C
	Peak On-State Current (100μs pulse, 120pps)	I _{TP}	2	A
	Peak Nonrepetitive Surge Current (Pw = 10ms, DC = 10%)	I _{TSM}	1.2	A
	Junction Temperature	T _j	115	°C
Storage Temperature Range	T _{stg}	-55~125	°C	
Operating Temperature Range	T _{opr}	-40~100	°C	
Lead Soldering Temperature (10s)	T _{sol}	260	°C	
Isolation Voltage (AC, 1 min., R.H. ≤ 60%)	BVS	2500	V _{rms}	

RECOMMENDED OPERATING CONDITIONS

CHARACTERISTIC	SYMBOL	MIN.	TYP.	MAX.	UNIT
Supply Voltage	V _{AC}	—	—	120	V _{ac}
Forward Current	I _F	15	20	25	mA
Peak On-State Current	I _{TP}	—	—	1	A
Operating Temperature	T _{opr}	-25	—	85	°C

INDIVIDUAL ELECTRICAL CHARACTERISTICS (Ta = 25°C)

CHARACTERISTIC		SYMBOL	TEST CONDITION	MIN.	TYP.	MAX.	UNIT
LED	Forward Voltage	V_F	$I_F = 10\text{mA}$	1.0	1.15	1.3	V
	Reverse Current	I_R	$V_R = 5\text{V}$	—	—	10	μA
	Capacitance	C_T	$V = 0, f = 1\text{MHz}$	—	10	—	pF
DETECTOR	Peak Off-State Current	I_{DRM}	$V_{DRM} = 400\text{V}$	—	10	100	nA
	Peak On-State Voltage	V_{TM}	$I_{TM} = 100\text{mA}$	—	1.7	3.0	V
	Holding Current	I_H	—	—	0.6	—	mA
	Critical Rate of Rise of Off-State Voltage	dv/dt	$V_{in} = 120\text{V}_{rms}, T_a = 85^\circ\text{C}$ (Fig.1)	200	500	—	$\text{V}/\mu\text{s}$
	Critical Rate of Rise of Commutating Voltage	$dv/dt(c)$	$V_{in} = 30\text{V}_{rms}, I_T = 15\text{mA}$ (Fig.1)	—	0.2	—	$\text{V}/\mu\text{s}$

COUPLED ELECTRICAL CHARACTERISTICS (Ta = 25°C)

CHARACTERISTIC	SYMBOL	TEST CONDITION	MIN.	TYP.	MAX.	UNIT
Trigger LED Current	I_{FT}	$V_T = 3\text{V}$	—	5	10	mA
Capacitance (Input to Output)	C_S	$V_S = 0, f = 1\text{MHz}$	—	0.8	—	pF
Isolation Resistance	R_S	$V_S = 500\text{V}$	5×10^{10}	10^{14}	—	Ω
Isolation Voltage	BV_S	AC, 1 minute	2500	—	—	V_{rms}
		AC, 1 second, in oil	—	5000	—	
		DC, 1 minute, in oil	—	5000	—	V_{dc}

Fig.1 : dv/dt TEST CIRCUIT

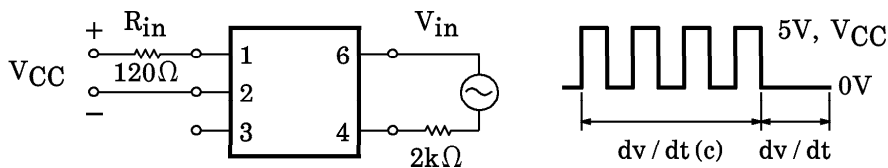

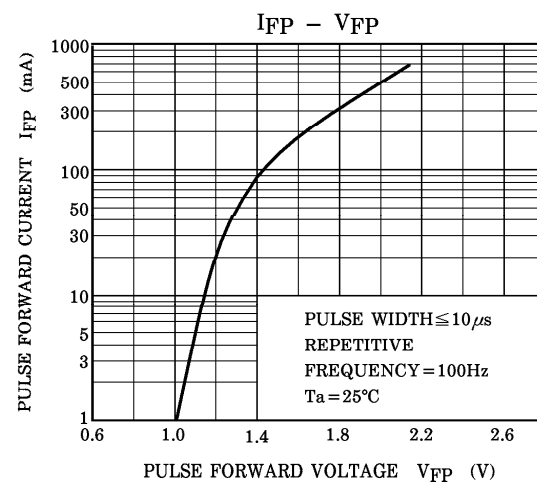
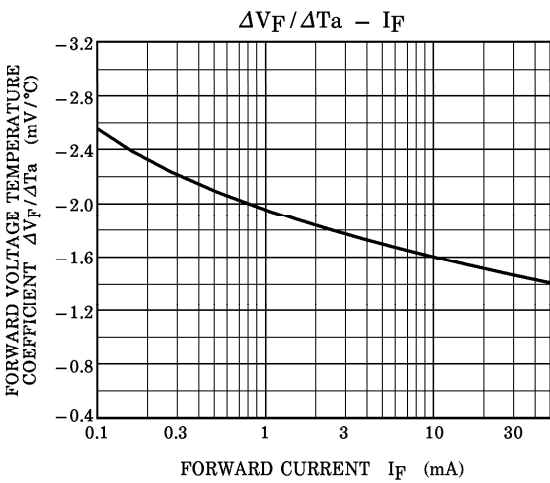
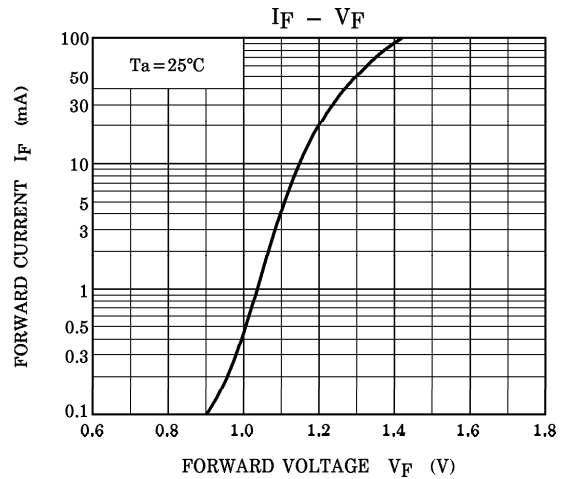
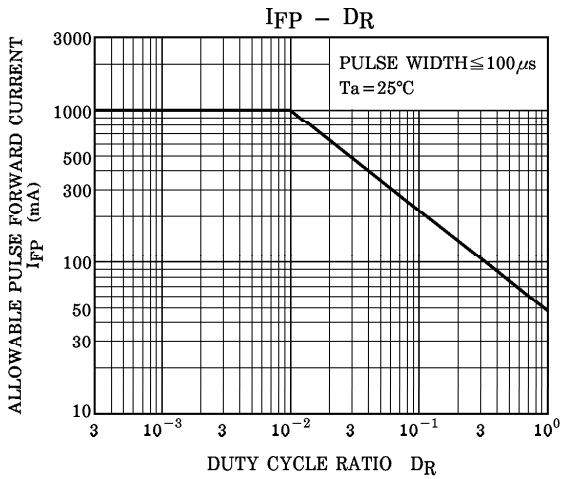
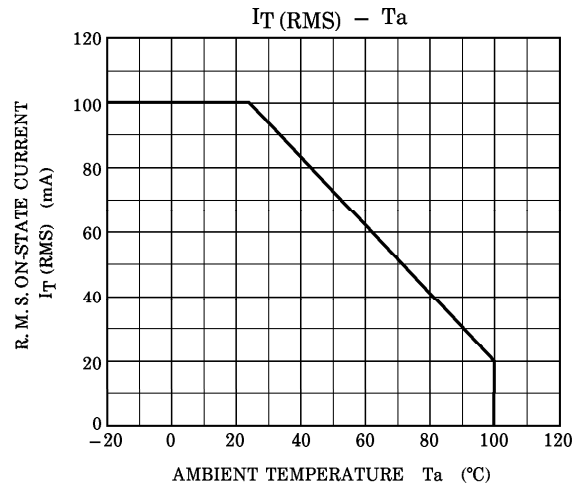
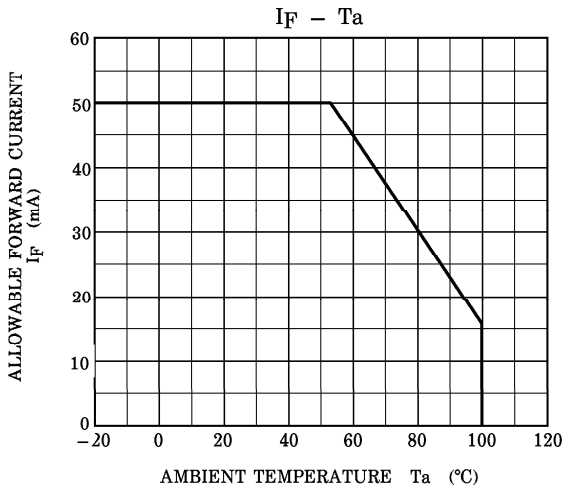

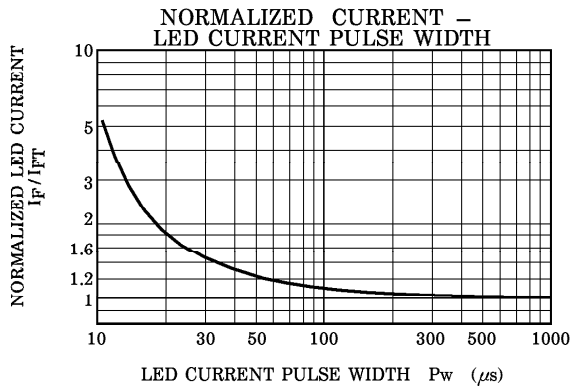
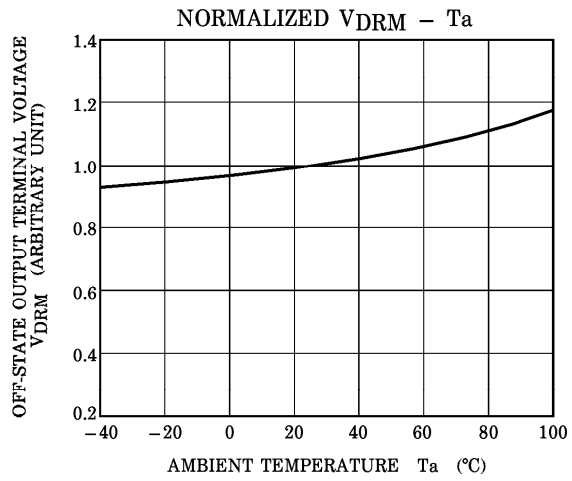
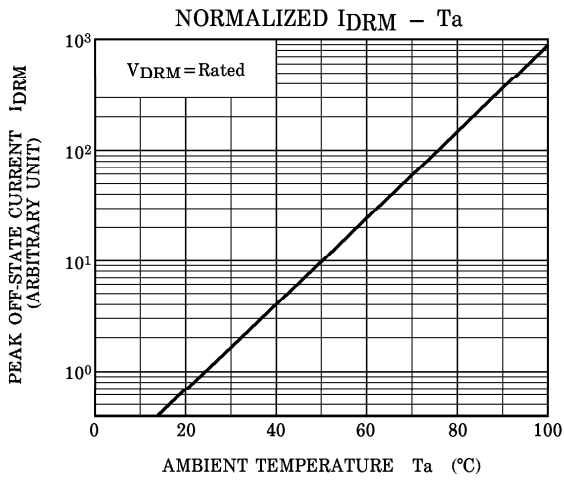
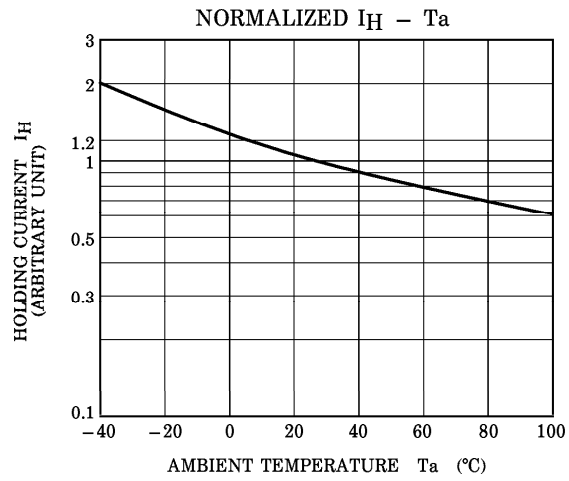
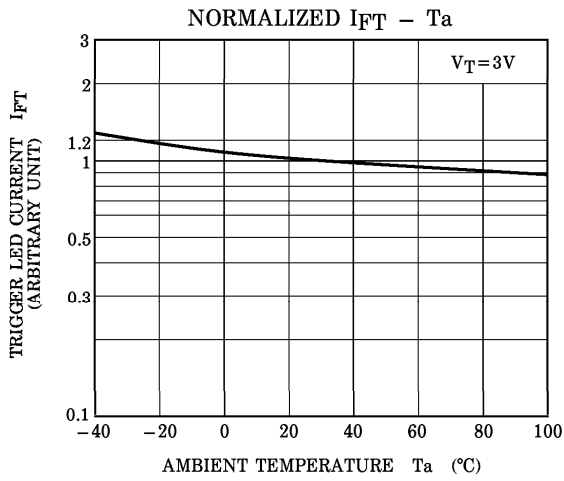

Copyright Each Manufacturing Company.

All Datasheets cannot be modified without permission.

This datasheet has been download from :

www.AllDataSheet.com

100% Free DataSheet Search Site.

Free Download.

No Register.

Fast Search System.

www.AllDataSheet.com